

DESCRIPTION

The TH-660 is a speaker horn to be used in combination with an optional driver unit. Its powder-coated finish, and stainless steel screws ensure the unit's weatherproof capability.

SPECIFICATIONS

Applicable Drivers	TU-631, TU-631M, TU-651, TU-651M
Sensitivity	110 dB (1 W, 1 m) (When operated with a driver.)
Frequency Response	200 Hz - 6 kHz (When operated with a driver.)
Dust/Water Protection	IP65 (When operated with a driver.)
Driver Coupling	1 - 3/8 18 threads (inch screw)
Operating Temperature	-20 °C to +55 °C (must be free from dew condensation)
Finish	Horn flare and flange: Aluminum, off-white, powder coating Reflector horn: ABS resin, off-white Bracket holder: Aluminum, gray, powder coating Bracket: Steel, gray, powder coating Screws and bolts: Stainless steel
Dimensions	ø600 x 425 (D) mm
Weight	3.6 kg

APPEARANCE

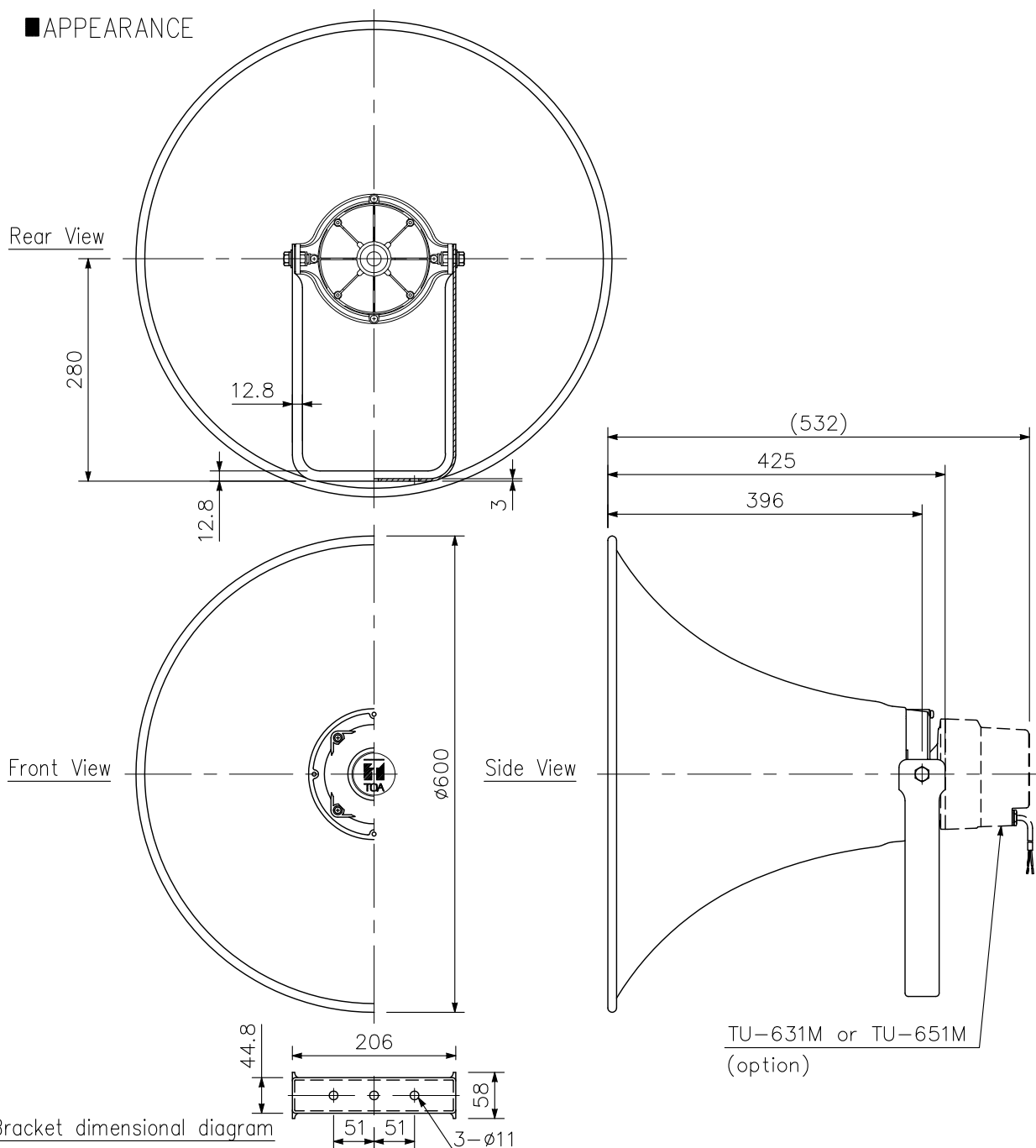

UNIT:mm SCALE:1/8